

This product contains an invisible infra-red 5mW laser.

Any dismantling of the product may result in dangerous exposure to laser radiation.

DANGER – INVISIBLE
LASER RADIATION WHEN
OPEN. AVOID DIRECT
EXPOSURE TO BEAM.

Detail of internal protective housing label, class 3, which is mounted on laser module.

This product is a class 1 laser product which complies with both USA21 CFR 1040.10 & 1040.11 and (BS) EN 608285-1

Please note that users are not required to access the laser radiation and should never do so.

LASER CM20**LASER INFORMATION****Introduction**

The Parker Laser CM20 Contamination Monitor represents the most upto- date technology in solid particle contamination analysis, **and** the first truly portable monitor.

Laser CM20 is a complex instrument, but at the same time has reliability, simplicity and ease of operation designed-in.

This owner's manual has been carefully prepared to guide you, the user, step by step through how to 'get started', how to obtain measurements and how to interpret the results. Additional information relating to the 'Aggressive Fluids' monitor is also included.

The real benefits to be gained from Laser CM20 will be achieved through regular use particularly as an effective comparator.

With a typical test taking only 2 minutes the opportunities for Laser CM20 as your standard fluid contamination monitoring instrument are considerable.

Above all, Laser CM20 has been designed to be used.

LASER CM20**CONTENTS****Contents**

	Page
LASER CM20 FEATURES	3.
LASER CM20 BENEFITS	4.
ANNOTATED DIAGRAMS	5.
GETTING STARTED	9.
BASIC OPERATION	13.
ADDITIONAL FEATURES	24.
DATA INTERPRETATION	25.
COMPONENT CLEANLINESS GUIDELINES	30.
ISO CONTAMINATION CHARTS	31.
HYDRAULIC CIRCUIT DIAGRAM	34.
LOGIC DIAGRAM	35.
DIAGNOSTICS	36.
REAR PANEL	39.
SPECIFICATIONS	40.
ORDERING INFORMATION	42.
OPERATION CHECK LIST	43.
'AGGRESSIVE FLUIDS'	44.

Features

Test Time:	2 minutes.
Repeat Test Time:	Every 2 minutes.
Principle of Operation:	Optical scanning analysis and measurement of actual particulates.
Particle counts:	4+,6+, 14+, 21+, 38+ and 70+ microns(c).
International codes:	ISO 7-22 NAS 0-12
Certification:	This product complies with all relevant EC declarations of conformity.
Memory store:	300 test (scrolling memory) capacity.
Calibration:	By accepted on-line methods confirmed by the relevant International Standard Organisation procedures.
Re-calibration:	Consult Parker.
Max. working pressure:	420 bar.
Max. flow rate:	400 l/min when used with System 20 Sensors. Higher with Single Point Sampler (Consult Parker).
Working Conditions:	Laser CM20 will operate with the system working normally.
Printer facility:	Integral 16 column printer for hard copy data.
Computer compatibility:	Interface via RS 232 connection @ 9600 baud rate.
Portability:	Only 8 kg. Laser CM20 has its own battery pack.
Power requirement:	Battery powered or via a 12vDC input (not supplied).
System connection:	Via System 20 Inline Sensors or the Single Point Sampler.
Leak free sampling:	System 20 sensors ensure sealed fluid extraction and no contamination ingress.

FAIL SAFE FEATURES

Special 'Diagnostics' are incorporated into the Laser CM20 micro processor control to ensure effective testing.

Circuitry:	Incorporates an internal diagnostic programme to ensure integrity of results.
Adequate flow:	Flow test facility ensures adequate flow.

DATA MANAGEMENT

A specially designed DATUM software package is available to enable downloading of test results onto a computer.

Benefits

- Routine contamination monitoring of oil systems with Laser CM20 saves time and saves money.
- Contamination monitoring is now possible while machinery is working – Laser CM20 saves on production downtime.
- Instant, accurate results are available to international standards in hard copy form. That means system maintenance decisions can be taken immediately.
- Laser CM20 ensures that machinery hydraulic systems are tested in manufacture to ISO cleanliness standards.
- Internal diagnostic feature ensures Laser CM20 will work accurately and reliably.
- Computer interfacing available for downloading data on to compatible computer.
- Totally portable, can be used as easily in the field as in the laboratory.
- Manufactured from lightweight Lexan foam which is both durable and strong.
- User friendly instrument improves familiarity and awareness of service and maintenance personnel.

Monitor – Front View

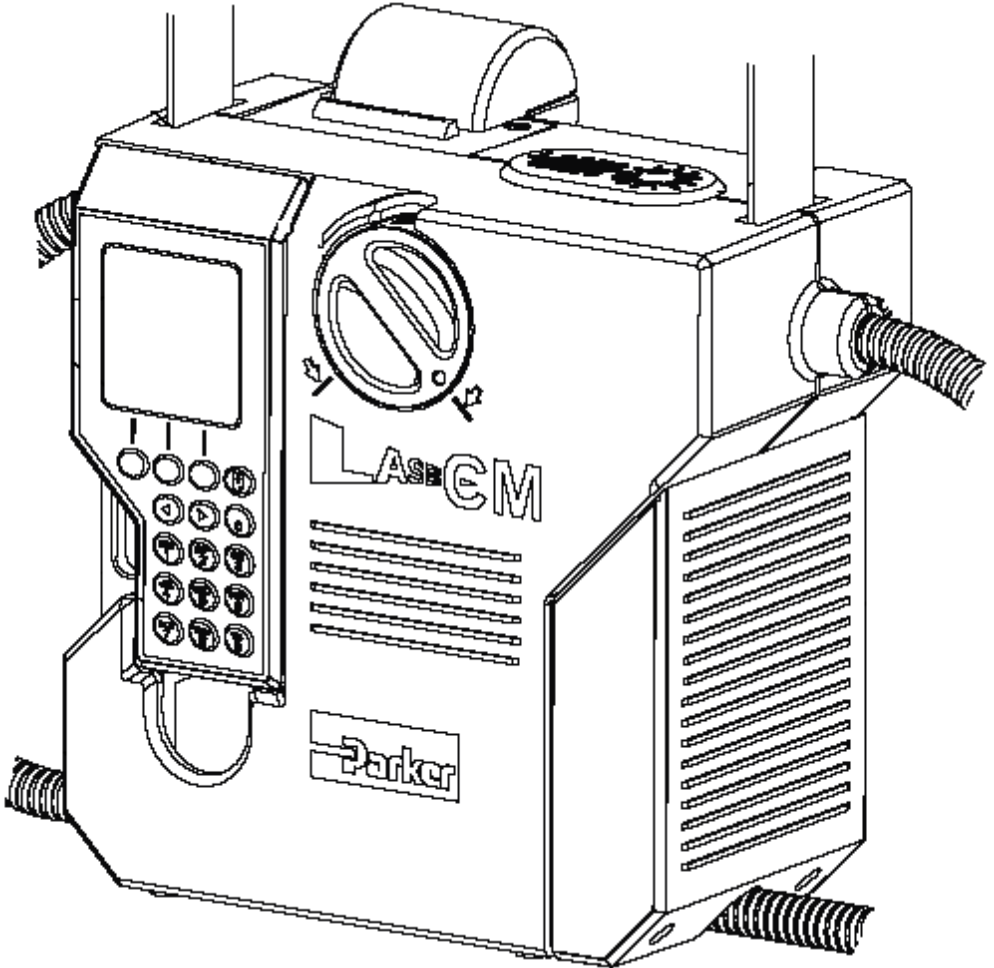

Monitor – Rear View

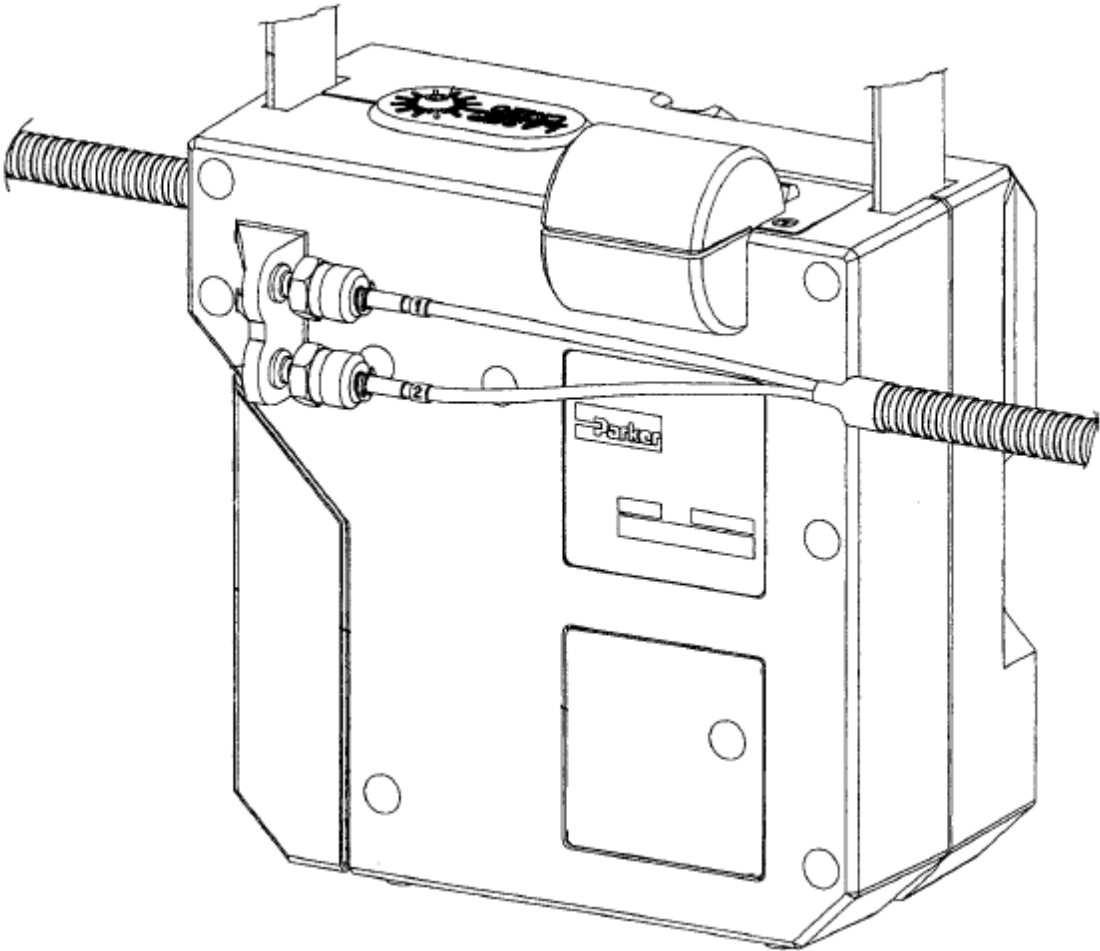

Hand-held Readout

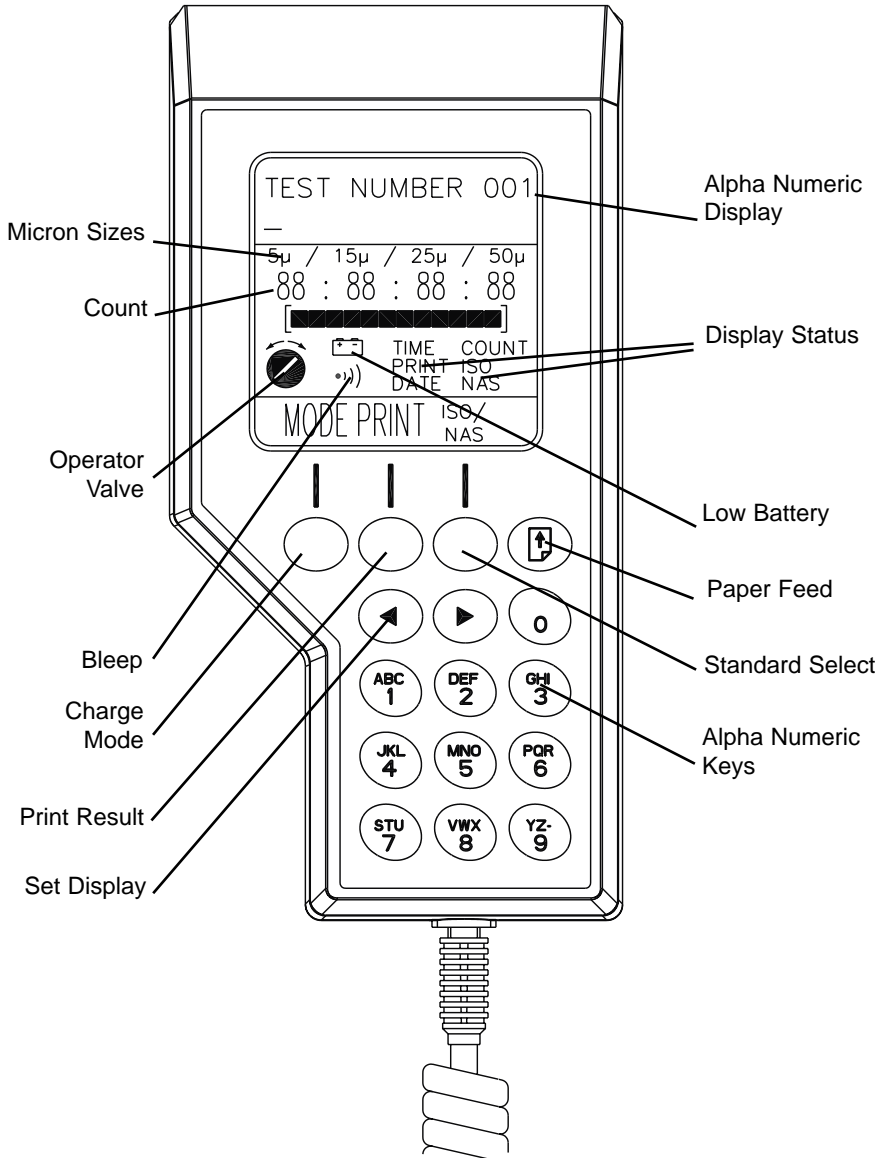

Battery Insertion

6x1.5 volt ALKALINE batteries are required.

Laser CM20 can also be powered from a regulated 12Vdc supply (see specifications page)

Step

1 Remove battery compartment

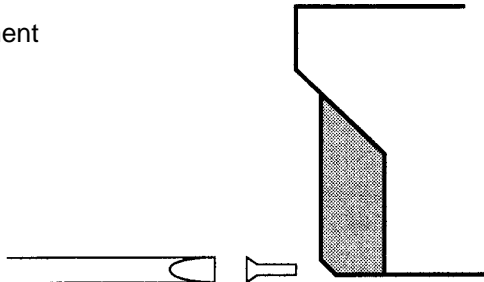

2 Insert batteries in the sequence shown

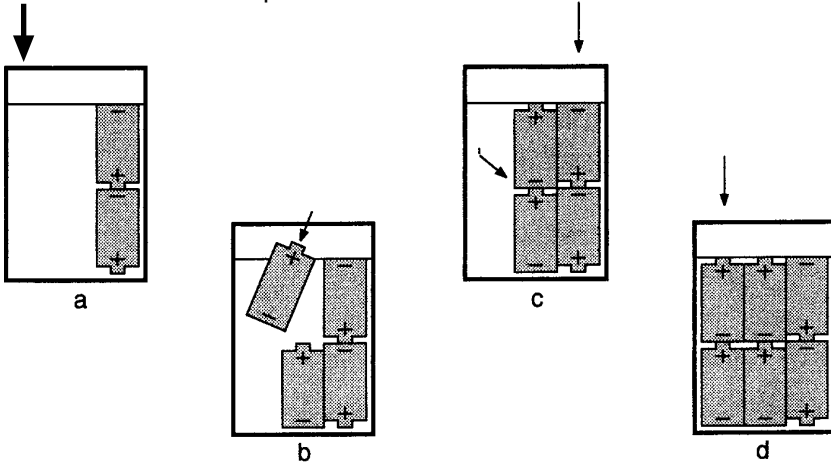

3 Replace battery compartment

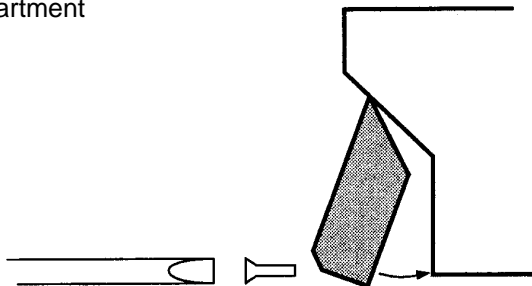

To set Laser CM20 to record time and date of tests.

PRESS

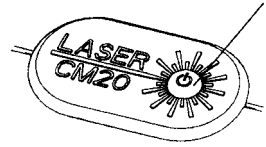

Step

- 1 Switch Laser CM20 on.
- 2 Remove handset and check display is working
Total display will remain on for 4 seconds.

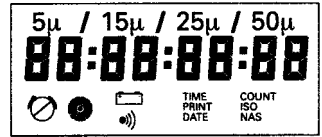

MODE

- 3 Press and hold  for 5 seconds.

Use  to move cursor under Y
if 'Memory Reset' is required.



Use  to move cursor under N
if 'Time and Date' reset is required.

MODE

Press  button.

- 4 Time mode displayed.
- 5 Enter correct time using numeric key pad.



1
Press. 



8
Press. 

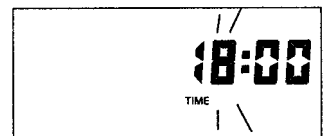

7 Press. **3** 

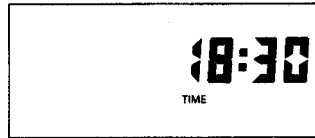

8 Press. **0** 

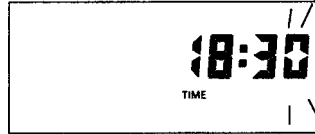

9 When correct time is **MODE** displayed press. 

To set date.

Step

- 1 Having confirmed time by pressing you are ready to set date.

MODE



- 2 Enter correct date using numeric keypad

1

Press.



5

Press.



3

0

Press.



4

Press.

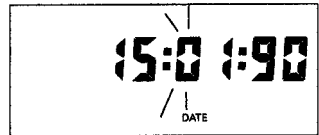

5

9

Press.



1

Press.

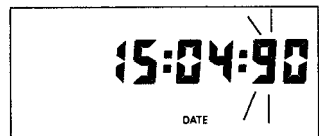

7

MODE

- 8 When correct date is displayed press.

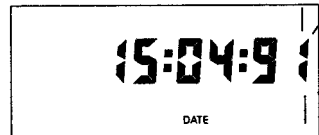

Installing paper and ribbon into the printer.

Step

1 Remove cover and reel axle.

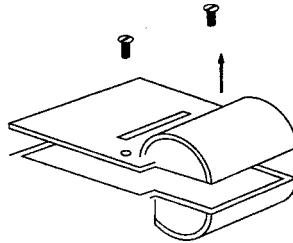

2 Place ribbon cassette in printer (follow numbered sequence)

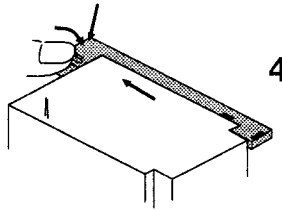
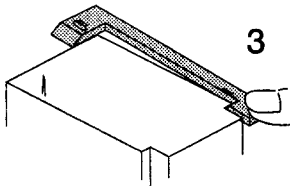
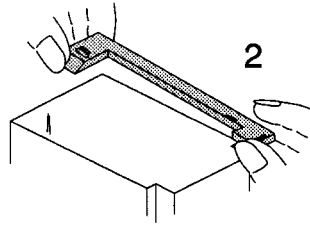
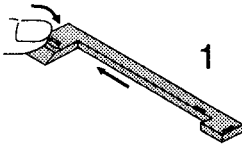

3 Feed paper under printer roller.

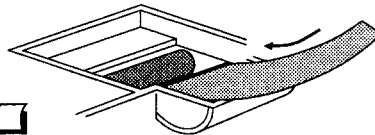

4 Press paper feed button on hand held unit.



5 Place paper in paperwell.

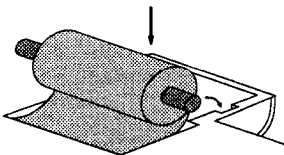

6 Feed paper through cover and secure cover.

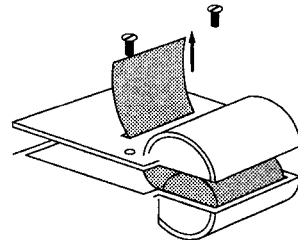

The Laser CM20 is now ready to check the cleanliness level of your system. Readings can be taken at full working pressure 420 bar (max.) In conjunction with System 20 Sensors.

Note: The Laser CM20 is supplied filled with hydraulic oil and may need to be flushed prior to use.

Step

- 1 Disconnect hydraulic hoses from the 'hose tidy'.

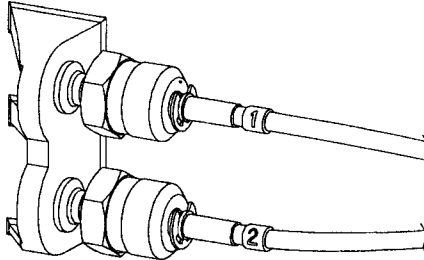

- 2 The Laser CM20 is designed for use in connection with System 20 size 0, 1 and 2 Industrial Sensors or the Single Point Sampler.

'X' DIA

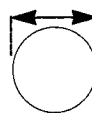

Note: 'Aggressive Fluids' monitor must be connected to a special System 20 Sensor or Single Point Sampler.

Industrial

SIZE	'X'
0	30.0
1	41.0
2	66.7

- 3 Ensure Sensor is installed with arrow in direction of flow
Working viscosity 2-100 cSt.

Ensure minimum working pressure of 2 Bar

Ensure adequate oil flow through Sensor

Size 0 – 12 litres per minute

Size 1 – 40 litres per minute

Size 2 – 160 litres per minute

Disconnect protection caps 1 and 2 only (red and yellow)

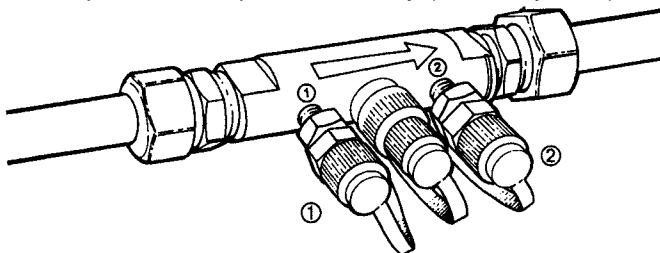

- 4 Connect red hose **1** loosely to Sensor inlet.

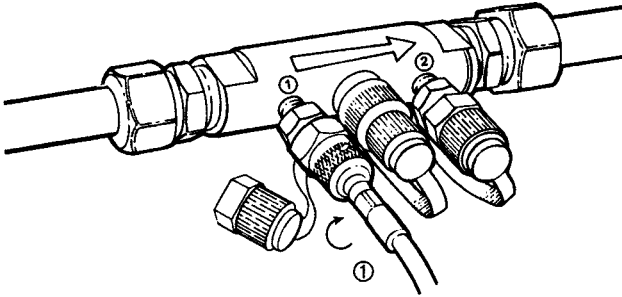

- 5 Connect yellow hose **2** loosely to Sensor outlet.

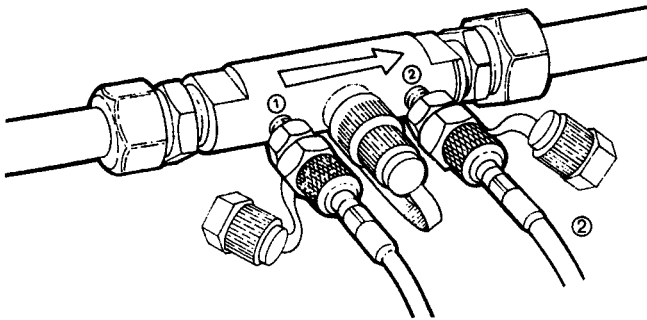

- 6 Simultaneously tighten the couplings finger tight.

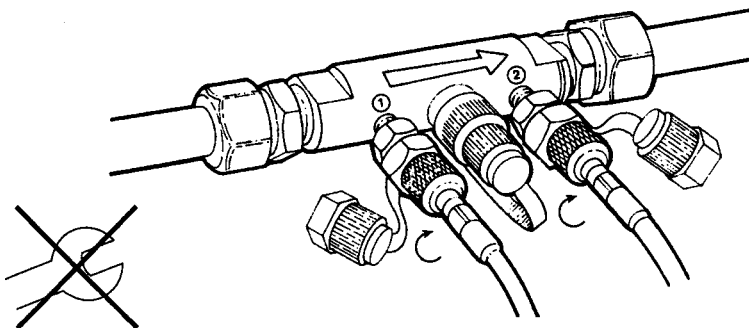

The Laser CM20 is now connected to the fluid to be checked.

We recommend Laser CM20 is connected to operating system sensor for 5 minutes to allow fluid condition to stabilise before commencing test.

It is also recommended that an independent flow check be carried out if there is high viscosity oil and low flow through System 20 sensor, or the unit is being operated without the trace heating option in cold ambient temperatures.

Independent Flow Test

1 Switch Laser CM20 on.

2 Press  for 5 seconds.

3 Flow test will commence, the display will show.

4 After 30 seconds the printer will print out the results of the flowtest.

5 A ΔT (Temp) of $\leq 03.60^{\circ}\text{C}$ or less is required for a successful test to be achieved.

6 If the ΔT value is $>03.60^{\circ}\text{C}$ then the flow rate through the System 20 Sensor should be increased or the system oil temperature raised.

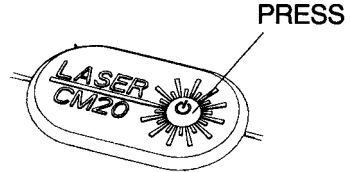

MANUAL FLOW TEST
IN PROGRESS

LASER CM FLOW
TEST

Date D M Y
 08 - 11 - 99

Time 11 - 19



T1 = 26.59°C

ΔT = 01.93°C

Step

- 1 Select ISO or NAS standard. This determines the format of test data stored. **ISO/NAS**



- 2 Observe position of operation control valve system  or 

- 3 Turn valve 90° in indicated direction. Valve position can be checked from the top of the Monitor....



.... or from the front of the Monitor.

Important:

Only turn the valve when starting a test and only when the valve turn symbol

 or  is shown on the display.

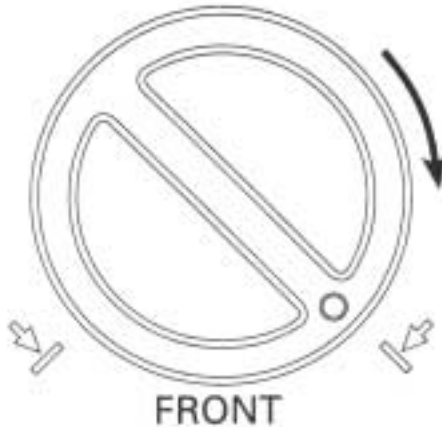

Testing will commence immediately

The test will take approximately 2 minutes. The duration bar will run across the screen for the duration of the test in 12 segments.

During each test, the appropriate test number will appear on the display. Example indicates test number 001 in progress.

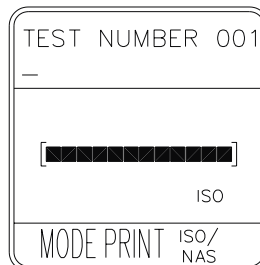

ISO Mode

Step

1 When the test is complete, the ISO Code will automatically be displayed.



2 **Particle count**
To obtain a count for the 4 μ (c) particles press the **MODE** button.



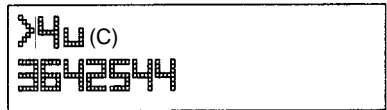

All particle counts are representative of 100 ml samples.

3 A count for 4 μ (c) will be displayed.

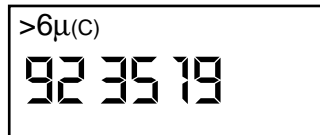

4 Press  for the 6 μ (c) count.



5 Press  again to obtain the 14 μ (c) count.

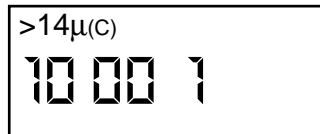

6 Press  again to obtain the 21 μ (c) count.

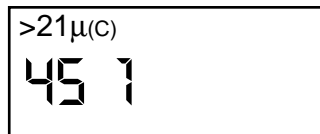

Step

7 Press  for the 38μ(C) count.

>38μ(C)

11

8 Press  once more for the 70μ(C) count.

>70μ(C)

0

9 Use  to return to previous particle count screen.

NAS Mode

When the test is complete the NAS Code will be displayed automatically.

Step

ISOINAS

- 1 Press the  button to set NAS mode. NAS class code will appear on the screen.



MODE

- 2 Press the  button to obtain the NAS count 4 μ (C) to 6 μ (C).

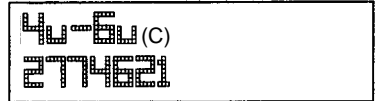

- 3 Press the  button to obtain the NAS count 6 μ (C) to 14 μ (C).



- 4 Press  again for the NAS count 14 μ (C) to 21 μ (C).

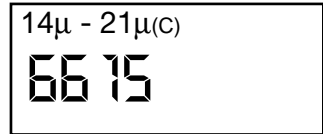

- 5 Press  again to obtain the 21 μ (C) to 38 μ (C) count.

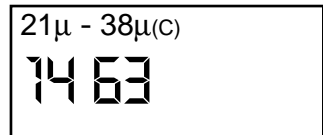

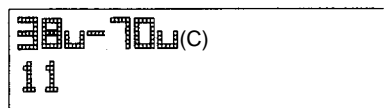

- 6 Press  again for th 38 μ (C) to 70 μ (C) count.

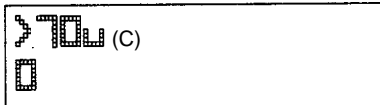

Step

7 Press  once more for the 70 μ (C) count.



Press  to return to previous particle count screen.

To print a result

To obtain a printout of the result in the ISO MODE

Step

1 Press the  **PRINT** button once to obtain the last result.

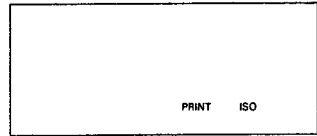

2 The printer will print the time, date and test number with ISO code and particle count.

Test No

```
.....  
UCC LASER CM  
ON-LINE TEST  
  
TEST NUMBER 017  
UNIT 19  
  
          D   M   Y  
Date      16 - 01 - 99  
Time      11 - 18  
ISO:      22 / 20 / 14(C)  
  
          Count/100ml  
>4µ(C)    3642544  
>6µ(C)    923519  
>14µ(C)   10010  
>21µ(C)   451  
>38µ(C)   11  
>70µ(C)   0  
  
NOTES  
  
.....  

```

To print all tests to date
Press the print button twice

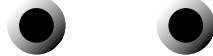
PRINT PRINT



Print stopped by pressing
a third time

PRINT



If the test count falls below ISO
code 7 or above ISO code 23
then 00 or 99 respectively will be
displayed under the 4µ, 6µ and
14µ symbols.

Next test

To obtain a printout of the test result in the NAS MODE

Step

1 Having completed the test in the NAS MODE.

Press the **PRINT** button once to obtain the last result.

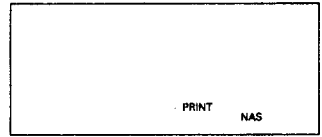

2 The printer will print the time, date and test number with NAS code and particle count.

Test No

```

.....
UCC LASER CM
ON-LINE TEST

TEST NUMBER 004
UNIT 19

                D   M   Y
Date           16 - 01 - 99
Time           09 - 16
NAS CLASS                    11

                Count/100ml
4/6µ(c)         2774621
6/14µ(c)        364534
NAS CLASS                    11
14µ/21µ(c)      6615
NAS CLASS                    8
21µ/38µ(c)      1463
NAS CLASS                    8
38µ/70µ(c)      1466
NAS CLASS                    11
>70µ(c)         97
NAS CLASS                    9

APPROVED

NOTES
.....
    
```

Next test

To print all tests to date
Press the print button twice

PRINT PRINT



Print stopped by pressing a third time

PRINT



If the test count falls below NAS class 0 or above NAS class 12 the 00 or 99 will be displayed above the NAS symbol.

Calibration Requirement

When switching the unit on, it will check the date as stored in the real-time clock against the date stored as the last calibration date.

If the date is within 4 weeks of the calibration due date, then the unit shall proceed as follows:



CALIBRATION DUE
29-06-2000

(this assumes a last calibration date of 29th June 2000)

To continue with testing press **MODE**



If the unit passes the recommended calibration due date, then the unit shall proceed as follows:



CALIBRATION
OVERDUE

To continue with testing press **MODE**



When the Laser CM20 is used with Datam, this will allow the unit to perform additional functions, such as:

- Automatic Testing
- Route Mapping

Additional Keys



The handset has two additional hot key functions

It is supplied with factory default contrast and backlight settings.

These settings are user adjustable as detailed below.

Press and hold **5 MNO**  and use  key to lighten the screen.

Press and hold **5 MNO**  and use  key to darken the screen.

Press and hold **7 STU**  and use  to switch backlight on.

Press and hold **7 STU**  and use  to switch backlight off.

NOTE:

When the CM20 is switched off the backlight function is reset.

Therefore if the backlight is still required when the CM20 is switched back on, the backlight will then need to be reactivated.

This is to preserve battery life.

Solid contaminants in fluid power systems vary in size, shape, form and quantity. The most harmful contaminants are normally between 6 micron and 14 micron. The ISO code is the preferred method of reporting quantity of contaminants.

The ISO code number corresponds to contamination levels pertaining to three sizes.

The first scale number represents the number of particles larger than 4µm(c) per 100 millilitre of fluid, the second number for particles larger than 6µm(c) per 100 millilitre of fluid and the third number for particles larger than 14µm(c) per 100 millilitre of fluid.

Below is a table of actual results, obtained, of contamination within a Hydraulic Pump endurance test rig.

Particle Size m(c)	No. of Particles per 100ml of oil
4 (c)	7950100
6 (c)	280500
14 (c)	1500
21 (c)	700
38 (c)	150
ISO code: 23/19/11	

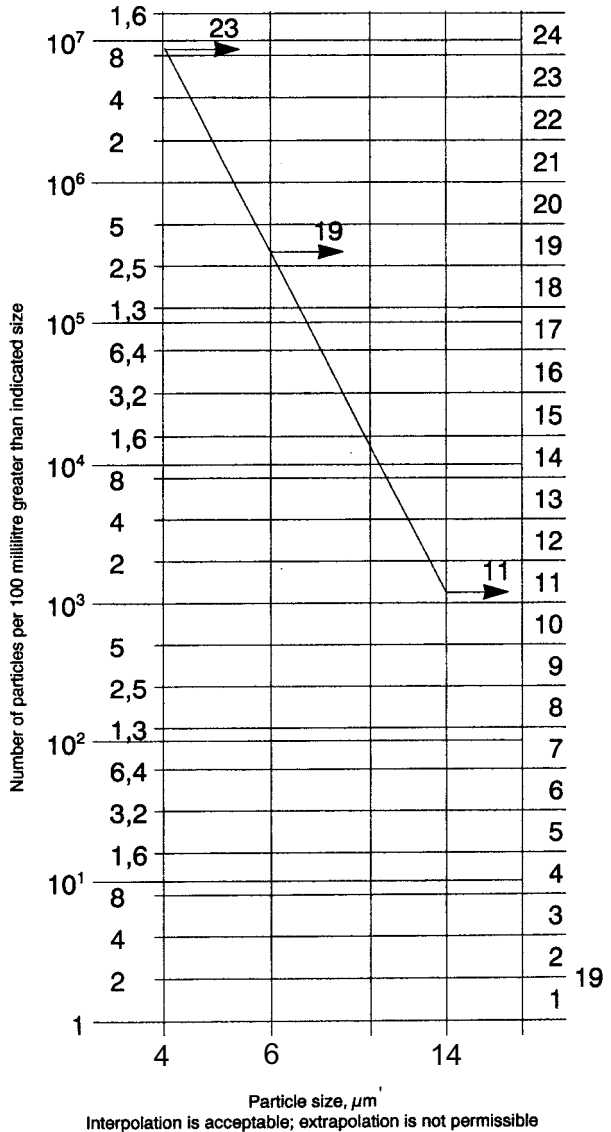

ISO Contamination Numbers

Number of particles per 100 ml		Range number
More than	Up to and including	
8×10^6	16×10^6	24
4×10^6	8×10^6	23
2×10^6	4×10^6	22
1×10^6	2×10^6	21
500×10^3	1×10^6	20
250×10^3	500×10^3	19
130×10^3	250×10^3	18
64×10^3	130×10^3	17
32×10^3	64×10^3	16
16×10^3	32×10^3	15
8×10^3	16×10^3	14
4×10^3	8×10^3	13
2×10^3	4×10^3	12
1×10^3	2×10^3	11
500	1×10^3	10
250	500	9
130	250	8
64	130	7
32	64	6
16	32	5
8	16	4
4	8	3
2	4	2
1	2	1

For example code 20/18/13 indicates that there are between 500,000 and 1,000,000 particles larger than 4 microns and between 130,000 and 250,000 particles larger than 6 microns and between 4000 and 8000 particles larger than 14 microns.

Particle Distribution Chart to ISO4406: 1999 Including various ISO level contamination grades

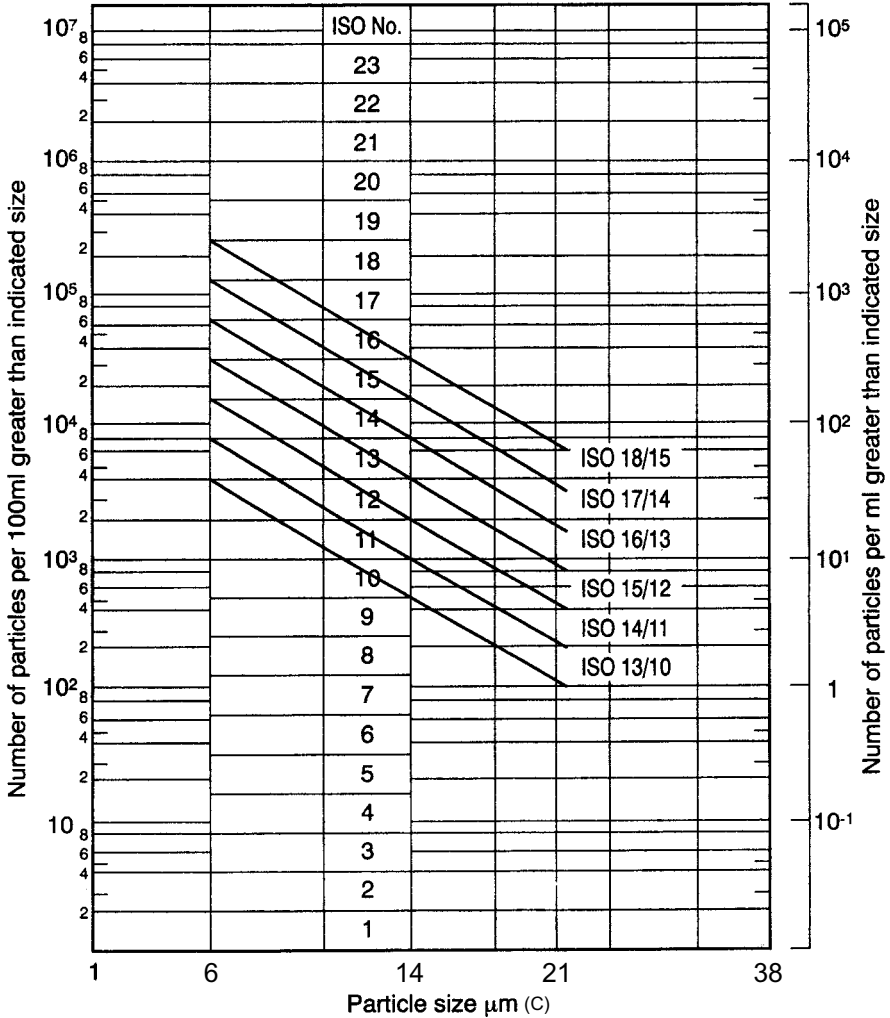

NAS 1638 Chart

NOTE: in order to implement the new MTD calibration with minimal impact on NAS cleanliness classes, the reference particle size ranges in NAS 1638 have been revised to relate to the particle size ranges in ISO 4406:1999. Therefore the NAS class cumulative counts have been aligned with ISO cumulative counts.

NAS 1638

SIZE RANGE µm(φ)	Classes (based on maximum contamination limits, particles per 100 mL)													
	00	0	1	2	3	4	5	6	7	8	9	10	11	12
6-14	125	250	500	1000	2000	4000	8000	16,000	32,000	64,000	128,000	256,000	512,000	1,024,000
14-21	22	44	89	178	356	712	1425	2,850	5,700	11,400	22,800	45,600	91,000	182,400
21-38	4	8	16	32	63	126	253	506	1,012	2,025	4,050	8,100	16,200	32,400
38-70	1	2	3	6	11	22	45	90	180	360	720	1,440	2,880	5,760
over 70	0	0	1	1	2	4	8	16	32	64	128	256	512	1024

ISO/NAS/SAE Comparison Chart

BS 5540/4 ISO/DIS 4406:1999 CODE	Def. Std 05/42		NAS 1638 Class	SAE 749 Class
	Table A	Table B		
11/8	-	-	2	-
12/9	-	-	3	0
13/10	-	-	4	1
14/9	-	400F	-	-
14/11	-	-	5	2
15/9	400	-	-	-
15/10	-	800F	-	-
15/12	-	-	6	3
16/10	800	-	-	-
16/11	-	1 300F	-	-
16/13	-	-	7	4
17/11	1 300	2 000F	-	-
17/14	-	-	8	5
18/12	2 000	-	-	-
18/13	-	4 400F	-	-
18/15	-	-	9	6
19/13	4 400	6 300F	-	-
19/16	-	-	10	-
20/13	6 300	-	-	-
20/17	-	-	11	-
21/14	15 000	-	-	-
21/18	-	-	12	-
22/15	21 000	-	-	-
23/17	100 000	-	-	-

The above comparisons relate to particle count data only. To conform to any particular standard, reference should be made to the recommended experimental procedure.

Suggested acceptable contamination levels for various hydraulic systems.

TARGET CONTAMINATION CLASS TO ISO 4406:1999		SUGGESTED MAXIMUM PARTICLE LEVEL		SENSITIVITY		TYPE OF SYSTEM		TYPICAL COMPONENTS	
6µm(c)	14µm(c)	6µm(c)	14µm(c)						
13	9	4,000	250	Super critical	Silt sensitive control system with very high reliability. Laboratory or aerospace.		High performance servovalves		
15	11	16,000	1,000	Critical	High performance servo and high pressure long life systems, i.e. aircraft, machine tools, etc.		Industrial servovalves		
16	13	32,000	4,000	Very Important	High quality reliable systems. General machine requirements.		Piston pumps, proportional valves compensated flow controls		
18	14	130,000	8,000	Important	General machinery & mobile systems. Medium pressure, medium capacity.		Vane pumps, spool valves		
19	15	250,000	16,000	Average	Low pressure heavy industrial systems, or applications where long life is not critical.		Gear pumps, manual and poppet valves cylinders		
21	17	1,000,000	64,000	Main protection	Low pressure systems with large clearances.		Ram pumps		

Typical system applications and code numbers

These typical applications and ISO code numbers are taken from the UK Contamination and Control Research Programme (1980-1984).
 Ref. AHM Guide to Contamination Control in Hydraulic Power Systems – 1985

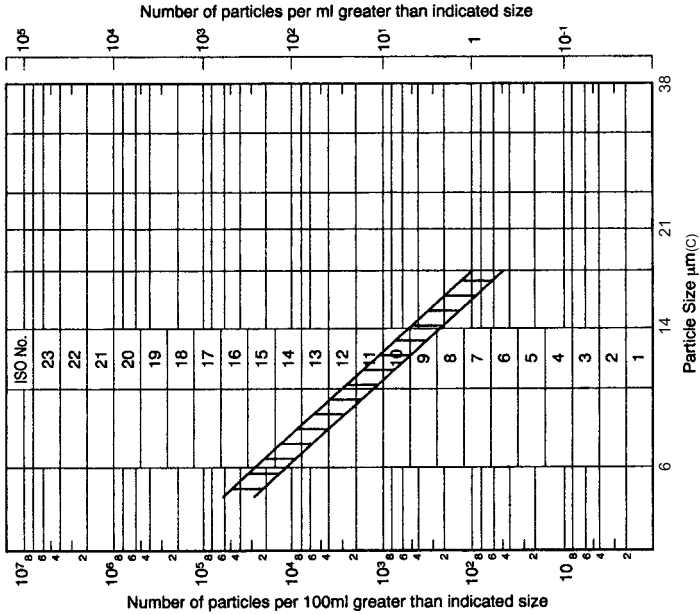

Solid Contaminant Code No 15/9
Application: Machine Tools

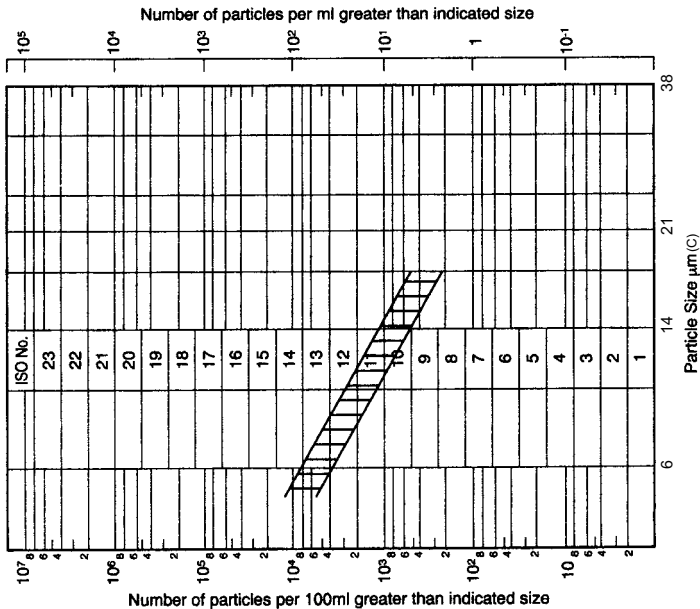

Solid Contaminant Code No 13/10
Application: Aircraft test stands

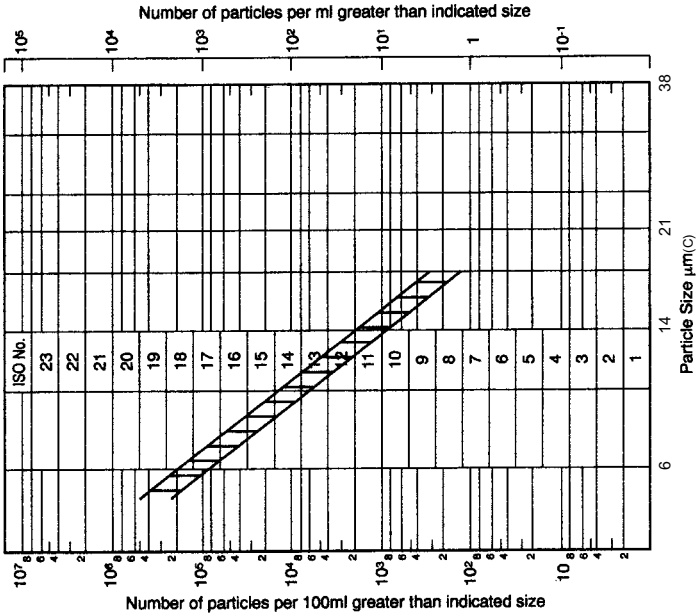

Solid Contaminant Code No 18/11
Application: Mobile Systems

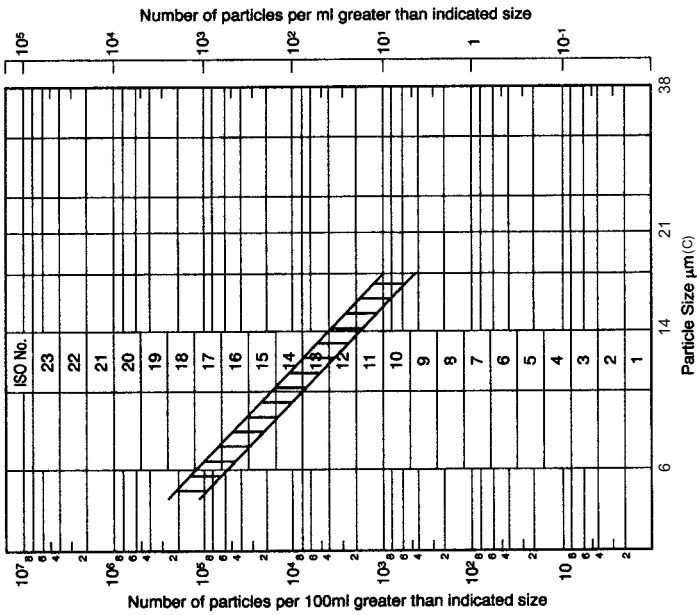

Solid Contaminant Code No 17/12
Application: Marine Installations

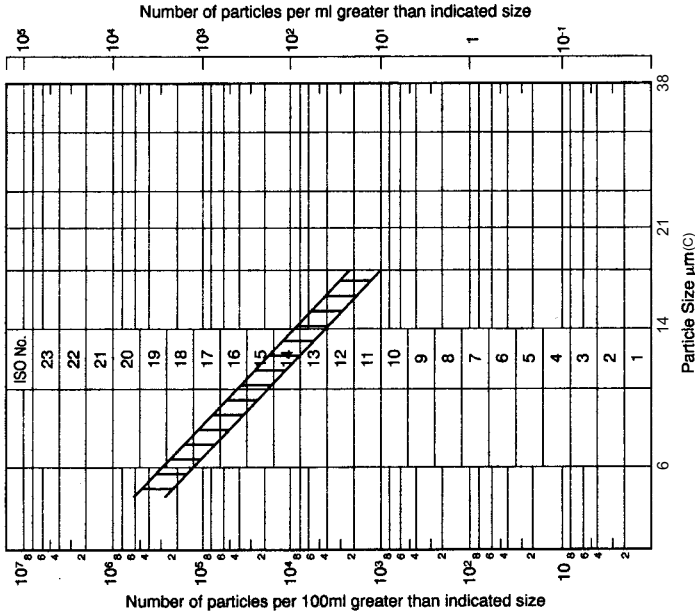

Solid Contaminant Code No 18/13
Application: Mechanical Handling

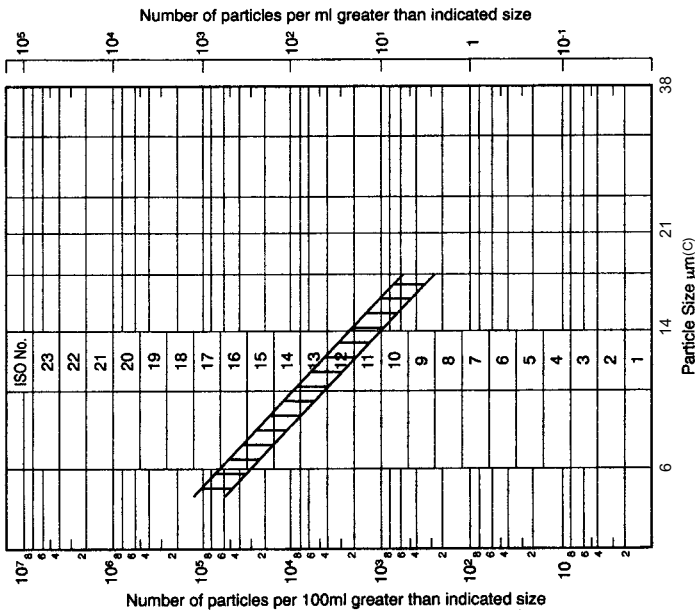

Solid Contaminant Code No 16/11
Application: Injection Moulding
Metalworking
Unused commercial grade oil

Diagrammatic representation only

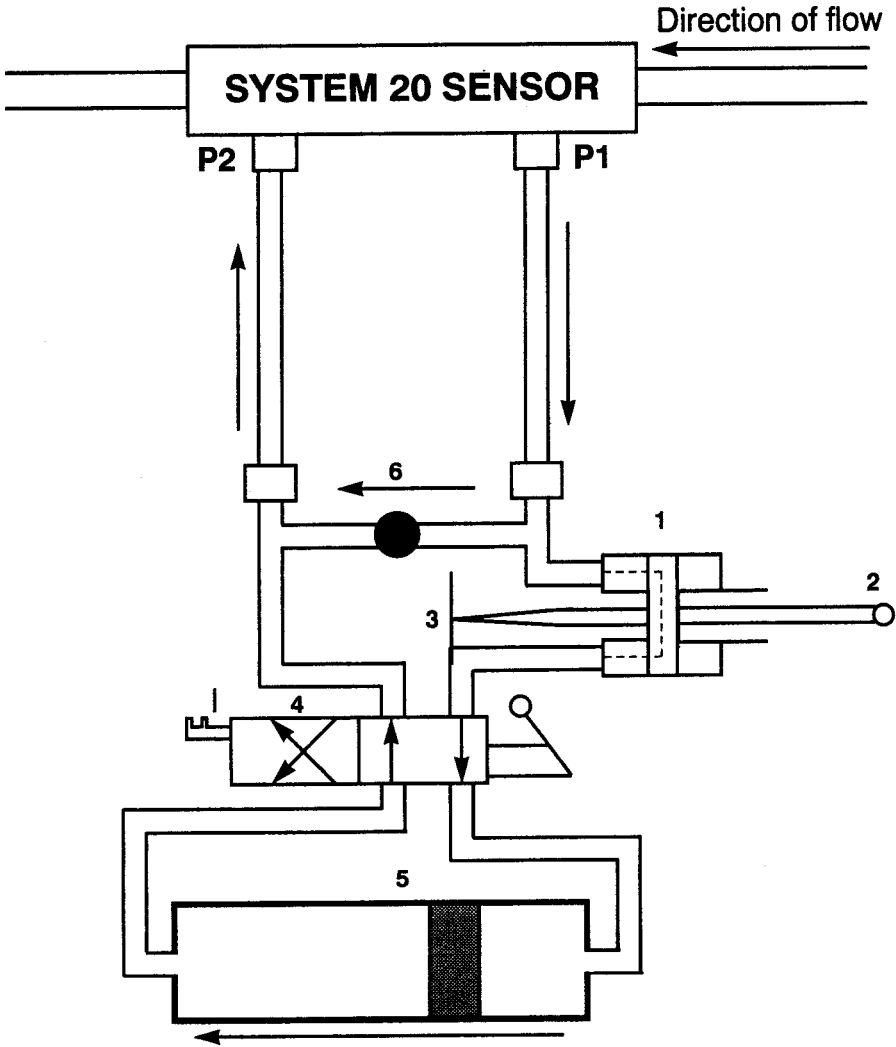

- 1. Monitor Block
- 2. Laser Diode
- 3. Optical Scanner
- 4. Changeover Valve
- 5. Dual Direction Syringe Pump
- 6. Flow Probe Device

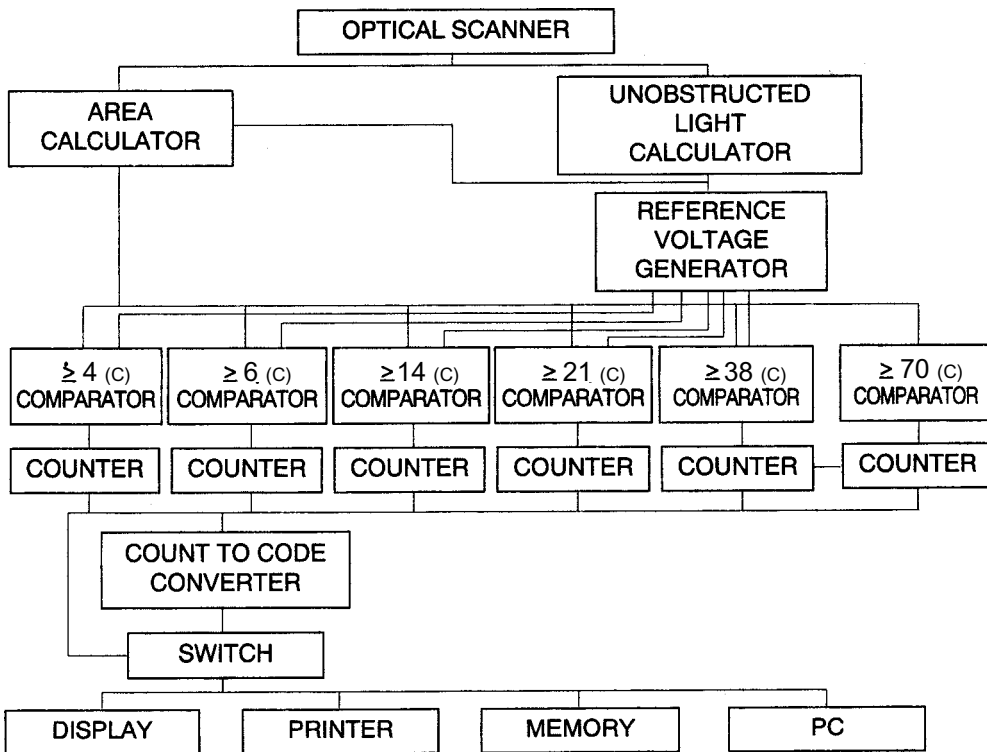

Repeatability

The Laser CM20 Instrument measures and quantifies individual particles. The sizing and counting of these particles, which is integrated within a complex electrical package, ensures a high degree of repeatability.

Calibration

Every monitor is individually calibrated using an accurately determined gravimetric level of test dust media.

Each channel within the instrument is adjusted to read the number of particles in a prescribed size range as specified in ISO procedures, thus guaranteeing calibration accuracy.

An Explanation of Laser CM20 diagnostic codes.

<p>Error 1. a. At beginning of test</p> <div style="border: 1px solid black; padding: 5px; text-align: center;"> <p>DIAG 1A. LIGHT SOURCE DEVIATION</p> </div>	<p>Oil is too dark or it is cloudy</p>	<p>Check sample of the oil visually. This can be done as follows:- Dark oils:- Wet your thumb and forefinger in the oil and press together. Release and look at your thumb. If you can see through the film of oil then it should work in Laser CM20. If you cannot then you may have problems. (This is normally engine oils or very highly contaminated oils above ISO 24)</p> <p>Emissions – put sample in clear container and hold up to the light, this will show cloudy or clear. If cloudy check the type of oil and change until the oil is clean. Then re-try Laser CM20.</p>
<p>b. At the end of the test</p> <div style="border: 1px solid black; padding: 5px; text-align: center;"> <p>DIAG 1B. LIGHT SOURCE DEVIATION</p> </div>	<p>Unstable fluid opacity may be caused by aeration water sludge or an amount of cold oil passing through Laser CM20.</p>	<p>Allow machine to work up to normal operating temperature before performing condition or monitoring. Run tests with a stable system and ensure that 2 bar minimum line pressure is available at the monitor to reduce the possibility of aeration.</p>
<p>Error 2. a. The changeover valve and syringe pump are out of phase</p> <div style="border: 1px solid black; padding: 5px; text-align: center;"> <p>DIAG 2 VALVE OPERATION ERROR</p> </div>	<p>a. Control knob turned, either before monitor switched on, before valve symbol displayed on handset or during a test. b. Time taken to turn valve fully to next position is too long (20 seconds.) c. Microswitch setting fault.</p>	<p>Switch off monitor, then switch on and wait for monitor to re-set its position (Diag 6 displayed). Start next test when valve symbol is displayed on handset.</p> <p>As in (a) above.</p> <p>Return to Parker for repair.</p>

<p>Error 3. a. Power to monitor has been disrupted</p> <div style="border: 1px solid black; padding: 5px; text-align: center;"> <p>DIAG 3 POWER INTERRUPTION</p> </div> <p>Error 4. insufficient flow rate of oil from P1 hose into monitor block to fill syringe pump. Results are suspect and are not made available.</p> <div style="border: 1px solid black; padding: 5px; text-align: center;"> <p>DIAG 4 LOW FLOW IN BYPASS LINE</p> </div> <p>Error 5. test time too short or too long.</p> <div style="border: 1px solid black; padding: 5px; text-align: center;"> <p>DIAG 5A TEST TIME TO SHORT</p> </div> <div style="border: 1px solid black; padding: 5px; text-align: center;"> <p>DIAG 5B TEST TIME TO LONG</p> </div>	<p>a. Uncontrolled power down by removing power supply without switching monitor off.</p> <p>b. Battery power too low. Battery level warning ignored.</p> <p>c. Battery contact disconnected by excessive vibration.</p> <p>d. Power supply connected (12V DC) while unit is on.</p> <p>a. Inadequate differential pressure across P1 and P2 connections to cause sufficient bypass flow.</p> <p>b. Air lock in monitor block or high viscosity slug of oil in bypass hoses.</p> <p>a. Malfunction of Opto-Tacho control, causing flow to stop before particle counting phase completed. Results are suspect and are not made available. Pump drive slipping or failed.</p> <p>b. DP too high due to lack of control of flow through Laser CM20.</p>	<p>Wait for monitor to reset itself.</p> <p>Replace batteries with 6 x 1.5V Alkaline D Cells (or re-chargepack if rechargeable pack is fitted.)</p> <p>Relocate monitor on a sound surface (May also be hung from a carrying strap).</p> <p>Leave unit to re-set itself.</p> <p>i) Select smaller sized sensor</p> <p>ii) Reduce viscosity of system oil by increasing test temperature where possible.</p> <p>iii) Use Single Point sampler connected to P1 (see Parker catalogue for details). Purge the system pressure with P2 hose disconnected from system.</p> <p>Care should be taken to allow oil discharge safely and should only be performed by a competent operator. Re-test and if fault repeats, return monitor to Parker for repair.</p> <p>Use SPS or sensor to control flow through Laser CM20</p>
---	--	---

<p>Error 6. Unit trying to re-set from last error.</p> <div style="border: 1px solid black; padding: 5px; text-align: center;"> <p>DIAG 6 LCM IN RESET MODE</p> </div>	<p>Displayed after switching on, while monitor is re-setting itself from previous error condition.</p>	<p>Leave it alone until it has re-set if it does not re-set, i.e. it switches itself off contact Parker .</p>
<p>Error 7 and above.</p> <div style="border: 1px solid black; padding: 5px; text-align: center;"> <p>DIAG 7 REFER TO CM20 SUPPLIER</p> </div> <div style="border: 1px solid black; padding: 5px; text-align: center;"> <p>DIAG 8 REFER TO CM20 SUPPLIER</p> </div> <div style="border: 1px solid black; padding: 5px; text-align: center;"> <p>DIAG 9 REFER TO CM20 SUPPLIER</p> </div>	<p>All faults which can only be rectified by Parker and are normally software diagnostic</p>	<p>Remove Laser CM20 from system connectors. Allow to cool down. If unit does not re-set, contact Parker.</p>
<p>DIAG 10 LASER TEMP TOO HIGH</p>	<p>Displayed if monitor block has reached temp. above 60°C</p>	<p>Remove Laser CM20 from system connectors. Allow to cool down. If unit does not re-set, contact Parker.</p>

LOW BATTERY

Replace batteries see section (4)
The Laser CM20 will not complete a measurement if the power is insufficient.

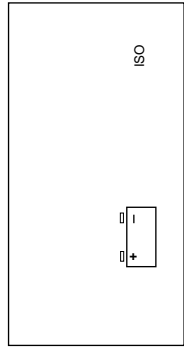

Peripherals and Serial interface.

Back Panel

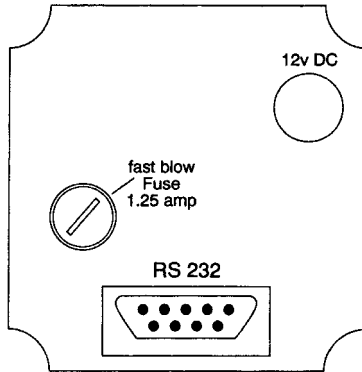

RS 232

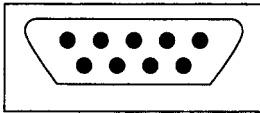

9 way connector to RS 232 output to down load all test data, stored in the instrument.

Construction: Case-Lexan structural foam and ABS. Hand-held display – ABS. Key pad fluorosilicone rubber.

Mechanical Components: Brass, plated steel, stainless steel and aluminium.

Seals: Viton.

Hoses: Nylon (Kevlar braided microbore).

Hose length: Fluid connection hose 1.2 metres (1 metre extensions can be used). Hand-held display cable length 1.0 metres.

Flow Rate: Up to 400 l/min (System 20 Sensors). Higher with Single Point Sampler – Consult Parker.

Max. Working Pressure: Up to 420 bar (System 20 Sensors).

Fluid Compatability: Mineral oil and petroleum based fluids. For other fluids consult Parker.

Power: Battery 6x1.5D cells Transformer supply voltage 9-12Vdc. Current 1.5 amp. Jack plug connection positive centre.



(Plug not supplied)

Fuse: 1.25 amp fast blow fuse included for overload protection.

LCM20 Technology: Unique optical scanning system.

Size, Measurement and Ranges: 4+, 6+, 14+, 21+, 38+ and 70+ micron (c).

Analysis Range: ISO 7 to 22 inclusive. (NAS 0-12 inclusive).

Calibration: Each unit is individually tested and calibrated in accordance with ISO procedures.

Repeatability/Accuracy: Better than 5% (typical).

Viscosity Range: 2-100 centistokes (500cSt with SPS).

Max. Operating Temp: +5°C to +80°C.

Environmental Temp: +5°C to +40°C.

Test Completion Time: 2 minutes.

Computer Interface: RS232 @ 9600 baud rate.

Laser CM20 Weight: 8 kg.

Installation Details

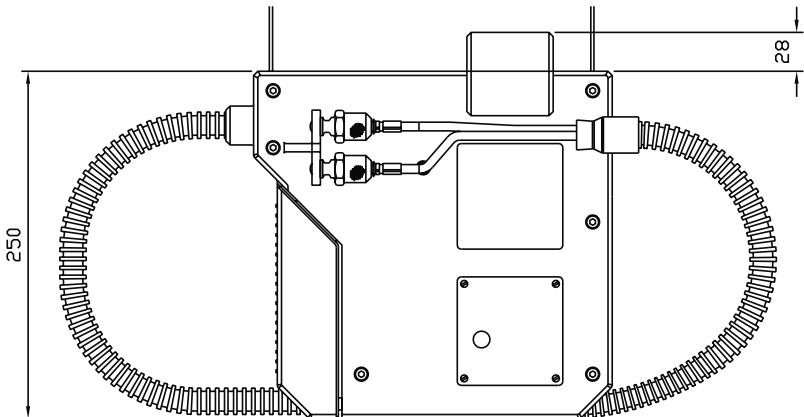
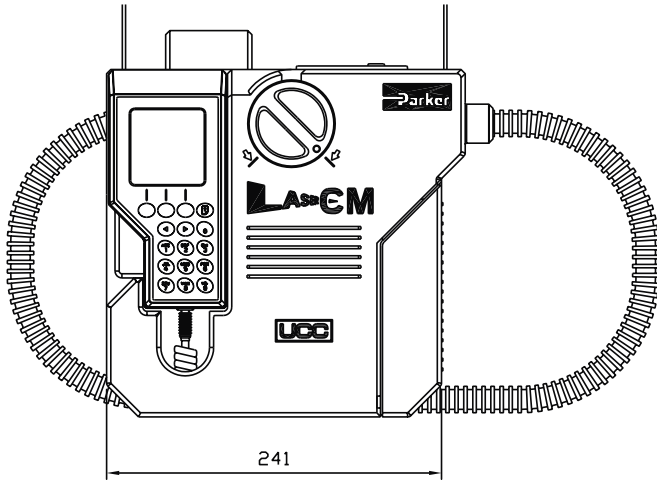
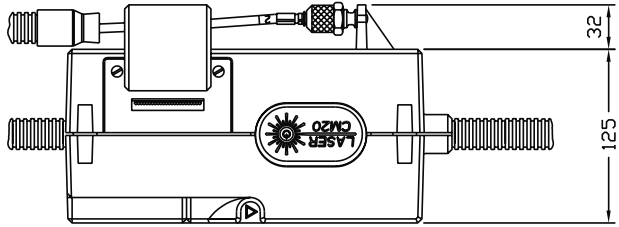

Part No.	Description	Qty.
LCM20.2021/2023	LCM 6 Channel (including carrying case and kit). ACFTD Calibrated	
LCM20.2022/2024	LCM 6 Channel MTD Calibrated	
P.843693.AB	Spare Astra Board case.	
B.84.702	Printer paper (to suit paper reel 44mm wide x 45mm diameter). Five rolls.	
P.843702	Printer ribbon.	
B.84.779	Datum System Monitoring Data Download.	
B.84.708	Cable Link Package.	
SPS. 2021	Single Point Sampler.	
B.84.609	Rechargeable battery pack.	
P.849613	Weather Protector Cover	
B.84.729	Power Supply	

Industrial Sensors - sizes 0,1 and 2

Part No.	Size	Flow Range	Thread	Qty.
STI.0144.100	0	6-25 l/min	G ³ / ₈	
STI.0344.100	0	0.5-7 US GPM	³ / ₄ UNF	
STI.1144.100	1	20-100 l/min	G ³ / ₄	
STI.1344.100	1	5-26 US GPM	SAE 1 ¹ / ₈ -12UN-2B	
STI.2144.100	2	80-380 l/min	G1 ¹ / ₄	
STI.2344.100	2	21-100 US GPM	SAE 1 ⁵ / ₈ -12UN-2B	

Always ensure:

- Sensors are installed correctly
- Sensor connectors are correctly tightened
- Adequate oil flow
- Steady state pressure conditions
- Oil viscosity is within working range
- Trend monitoring is performed under similar working conditions
- Correctly stowed hoses to avoid fluid spillage
- Sufficient paper supplies for hard copy printer
- Handle Laser CM20 with care – Instrumentation product
- Re-order spares in advance
- Calibrated within Parker recommendations

To expand further the applications possible with Parker's Laser CM20 particle counting technology, we are now able to offer a version of Laser CM20 utilising ISOLAST dual seal technology.

Calibrated in accordance with ISO procedures, on a specially commissioned Skydrol calibration rig. The LCM20.2062 offers the user all the features and benefits of the already proven and world-wide accepted Laser CM20 technology.

By using LCM20.2062, civil aviation hydraulic servicing operations can now parallel the cost and time saving already demonstrated in the military aviation industries.

*Ref.; Parker Technical Update UC.TU.9303.

THIS PRODUCT IS COMPATIBLE WITH
BOTH MINERAL AND AGGRESSIVE FLUIDS.

AVOID CROSS CONTAMINATION BY
FLUSHING THIS MONITOR.
IF IN DOUBT CONTACT PARKER.

NOTE:

Some oils may be classified as Phosphate Esters, but may not be aggressive. If in doubt with fluid/seal compatibility, consult Parker

Features:

- Isolast seals throughout.
- Totally compatible for Aggressive Phosphate Esters (e.g. SKYDROL LD4/500B)
- Red control valve knob and hand set keys for easy identification against standard Laser CM20 units
- High Technology, fused optical windows for high particle definition
- Available with complete range of sample extraction options (e.g. System 20 Sensors or Single Point Sampler)
- 5/8" BSF HSP Hose fitting
- Parylene treated for additional protection

Part No.	Description	Qty.
LCM20.2061/2063	Laser CM20 'Aggressive Fluids' ACFTD Calibrated	
LCM20.2062/2064	Laser CM20 'Aggressive Fluids' MTD Calibrated	
P.843693.AB	Spare Astra Board case.	
B.84.702	Printer paper (to suit paper reel 44mm wide x 45mm diameter). Five rolls.	
P.843702	Printer ribbon.	
B.84.779	DATUM System Monitoring Data Download.	
B.84.708	Cable Link Package.	
SPS.2061	Single Point Sampler.	
B.84.609	Re-chargeable battery pack.	
B.84.729	Power Supply.	
P.849624	Hand Set cover.	

System 20-Sensors

Industrial Sensors - sizes 0,1 and 2

Part No.	Size	Flow Range	Thread	Qty.
STI.0148.100	0	6-25 l/min	G ³ / ₈	
STI.0348.100	0	0.5-7 US GPM	³ / ₄ UNF	
STI.1148.100	1	20-100 l/min	G ³ / ₄	
STI.1348.100	1	5-26 US GPM	SAE 1 ¹ / ₁₆ -12UN-2B	
STI.2148.100	2	80-380 l/min	G1 ¹ / ₄	
STI.2348.100	2	21-100 US GPM	SAE 1 ⁵ / ₁₆ -12UN-2B	